









**MEM Deck-mounted basin spout without pop-up waste - Brushed Durabross (23kt Gold)**

MEM

13 716 782



- 200mm projection
- fixed spout
- rectangular, air-enriched flow
- height of mixer 321 mm
- height up to aerator 190 mm
- hole diameter 35 mm
- rosette 60 x 60 mm
- 2x screw-in M 10 x 1 pressure hose, leak-tested
- 1/2" connection
- max. flow 5.7 l/min
- lead-free
- This product can help a building meet the requirements of Green Building Rating Systems, e.g. LEED®, BREEAM®, DGNB

	Brushed Durabross (23kt Gold)	13 716 782-28
	Chrome	13 716 782-00
	Brushed Platinum	13 716 782-06
	Platinum	13 716 782-08
	Dark Chrome	13 716 782-19
	Brushed Champagne (22kt Gold)	13 716 782-46
	Champagne (22kt Gold)	13 716 782-47
	Brushed Dark Platinum	13 716 782-99

13 716 782  
mm [inches]

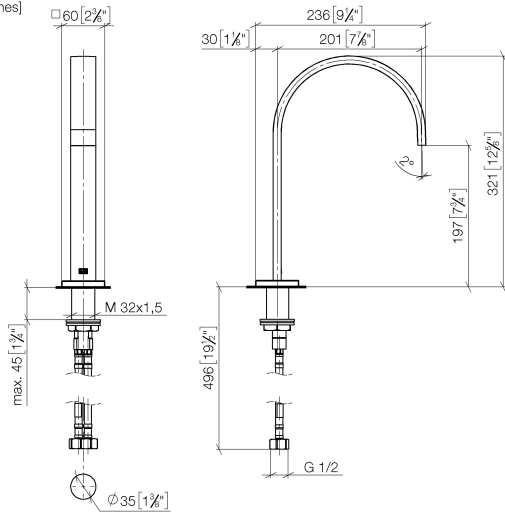

**Flow rate chart**

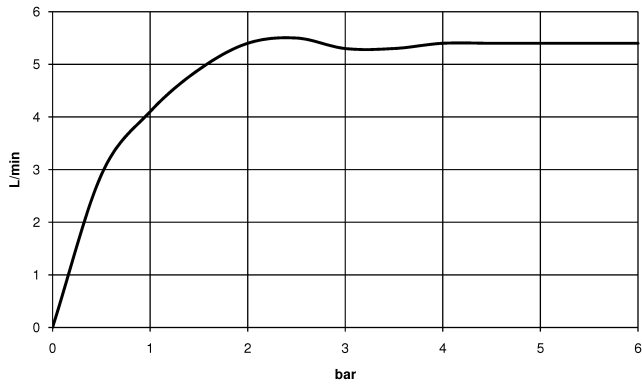

**Certificates**

LGA\_28441.

GDV\_0400289.

**MEM Deck-mounted basin spout without pop-up waste - Brushed Durabronz  
(23kt Gold)**

MEM

13 716 782

Parts for other  
finishes can be found  
here: Chrome

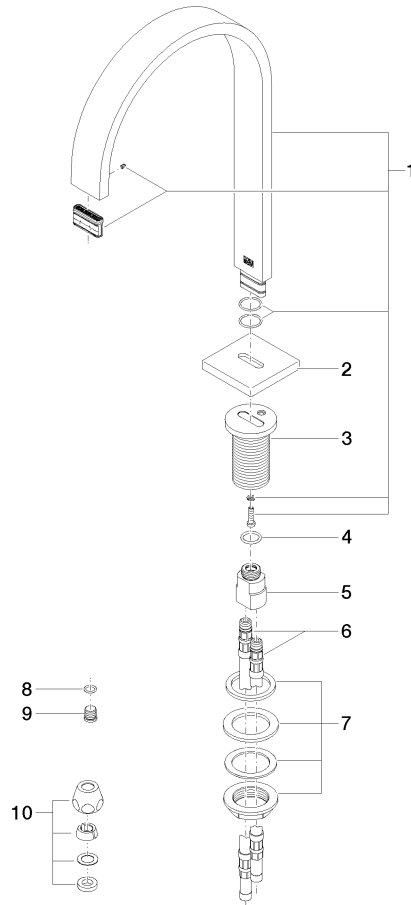

**Spare parts list**

No.	Item Number	Name	Quantity used	Delivery time
1	90 28 22 155 01-28	spout	1	20
2	09 27 78 034-28	rosette	1	20
3	09 11 10 054 10 90	connection	1	2
4	09 14 10 130 90	seal	1	2
5	09 11 10 055 10 90	connection	1	2
6	04 30 04 016 00 90	hose	2	60
7	04 23 10 009 01 90	fixing set	1	2
8	90 14 10 060 00 90	seal	1	2
9	09 31 20 065 90	plug	1	2
10	90 23 30 040 00-28	threaded connector	2	20